



Installation & Operation Manual



Download
Manual



Growatt New Energy

Shenzhen Growatt New Energy Technology CO.,LTD
No.28 Guangming Road, Shiyan Street, Bao'an District,
Shenzhen, P.R.China

T +86 755 2747 1942

E service@ginverter.com

W www.ginverter.com

GR-UM-160-A-00

Index

1 Notes on this Manual

- 1.1 Validity
- 1.2 Target Group
- 1.3 Additional information

2 Introduction

- 2.1 Foreword
- 2.2 Applicable personnel
- 2.3 Product overview and features
- 2.4 Safety instructions

3 Product Description

- 3.1 Appearance overview
- 3.2 Dimensions
- 3.3 Storage environment

4 Unpacking and Inspection

5 Installation

- 5.1 Basic installation requirements
- 5.2 Mounting wall mount
- 5.3 Installing the inverter

6 Inverter Wiring

- 6.1 Safety
- 6.2 AC side wiring
- 6.3 DC side wiring
- 6.4 Connecting signal line

7 Debugging

8 Operating Mode

- 8.1 Normal mode
- 8.2 Failure mode
- 8.3 Shutdown mode

9 OLED Display and Touch Buttons

- 9.1 Boot display
- 9.2 OLED display wake up
- 9.3 Touch operation

10 Communication and Monitoring

- 10.1 RS485
- 10.2 DRM
- 10.3 USB-A

11 Start the Inverter

- 11.1 Start the inverter
- 11.2 Shut down the inverter

12 Fan Maintenance

13 Troubleshooting

- 13.1 Error message
- 13.2 System error

14 Specification

- 14.1 Parameter
- 14.2 Torque
- 14.3 Annex

15 Contact us

1 Notes on this Manual

1.1 Validity

This manual describes the assembly, installation, commissioning and maintenance of the following Growatt Inverter model:

MID 6KTL3-XL	MID 10KTL3-X
MID 8KTL3-XL	MID 12KTL3-X
MID 10KTL3-XL	MID 15KTL3-X
MID 11KTL3-XL	MID 17KTL3-X
MID 12KTL3-XL	MID 20KTL3-X
	MID 22KTL3-X
	MID 25KTL3-X

This manual does not cover any details concerning equipment connected to the MID TL3-X and MID TL3-XL (e.g. PV modules). Information concerning the connected equipment is available from the manufacturer of the equipment.

1.2 Target Group

This manual is for qualified personnel. Qualified personnel have received training and have demonstrated skills and knowledge in the construction and operation of this device. Qualified Personnel are trained to deal with the dangers and hazards involved in installing electric devices.

1.3 Additional Information

Find further information on special topics in the download area at www.ginverter.com. The manual and other documents must be stored in a convenient place and be available at all times. We assume no liability for any damage caused by failure to observe these instructions. For possible changes in this manual, GROWATT NEW ENERGY TECHNOLOGY CO.,LTD accepts no responsibilities to inform the users.

2 Introduction

1.2 Foreword

This manual will provide detailed product information and installation instructions for users of Shenzhen Growatt New Energy Co., Ltd. (hereinafter referred to as Growatt New Energy) MID TL3-X series PV inverters. Please read this manual carefully before using this product. Any changes to this manual by Growatt New Energy will not be notified to the user.

MID 6KTL3-XL	MID 10KTL3-X
MID 8KTL3-XL	MID 12KTL3-X
MID 10KTL3-XL	MID 15KTL3-X
MID 11KTL3-XL	MID 17KTL3-X
MID 12KTL3-XL	MID 20KTL3-X
	MID 22KTL3-X
	MID 25KTL3-X

2.2 Applicable Personnel

The inverter must be installed by a professional electrician qualified by the relevant department. By reading this manual in detail, the installer can install the MID TL3-X series inverters correctly and quickly, and can perform troubleshooting and communication system setup.

If there are any problems during the installation process, the installer can log on to www.growatt.com to leave a message or call our 24-hour service number: 400-833-9981.

2.3 Product Overview and Features

2.3.1 Product overview

The Growatt series of photovoltaic inverters are used to convert the direct current generated by photovoltaic panels into alternating current and deliver them to the grid in three phases. The Growatt MID TL3-X and MID TL3-XL series inverters can be connected to two strings and have two maximum power tracking point trackers, so it is suitable for connecting two different arrays of panels.

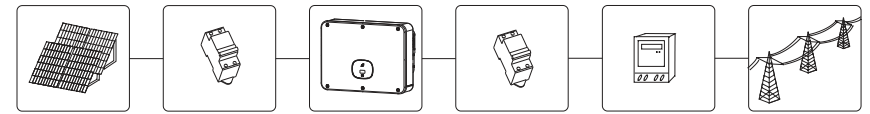

fig2.1 Connecting to the grid

position	description
A	Solar panel
B	DC circuit breaker
C	Inverter
D	AC circuit breaker
E	Energy meter
F	Utility grid

As shown in Figure above, a complete PV grid-connected system includes PV modules, PV inverters, public grids, and other components. In photovoltaic module systems, photovoltaic inverters are the key component.

Note: If the selected PV module requires the positive or negative grounding, please contact Growatt for technical support before installation.



2.3.2 Product features

The characteristics of the inverter are as follows:









- Dual independent maximum power point tracking
- Built-in DC switch
- Compatible with RS485/Wifi / GPRS / 4G communication
- 200V-1000V input voltage range
- Maximum efficiency up to 98.65%
- OLED display
- Touch button
- Protection level IP65
- Weighs only 23kg
- Easy installation

2.4 Safety Instructions

- 1) Please read this manual carefully before installation. If the equipment is not installed according to the instructions in this manual, or if the equipment in the manual is ignored, the company has the right to not guarantee the quality;
- 2) All operations and wiring, please operate by professional electrical or mechanical engineers;
- 3) When installing, please do not move the other parts inside the chassis except the terminal block;
- 4) All electrical installations must comply with local electrical safety standards;
- 5) If the machine requires maintenance, please contact the local designated system installation and maintenance personnel;
- 6) The use of this machine for grid-connected power generation requires the permission of the local power supply department;
- 7) When installing PV modules during the day, use opaque materials to cover the PV modules. Otherwise, in the sunlight, the voltage at the component terminals is high, which poses a personal danger.

 Danger	<p>Make sure that the input DC voltage does not exceed 550V under any circumstances. Higher input voltages may permanently damage the machine and cause other damage, in which case the company does not warrant and assumes any responsibility.</p>
 Warning	<p>During the operation of the machine, the surface temperature of the outer casing is high. Please carefully touch the outer casing to prevent burns.</p>

2.4.1 Sign convention

Sign	Explanation
	High voltage danger
	Plammable and explosive
	High temperature
	Wait 5 minutes after power off to ensure the machine is fully discharged
	Safety ground
	DC
	AC
	Read the manual carefully

3 Product description

3.1 Appearance Overview

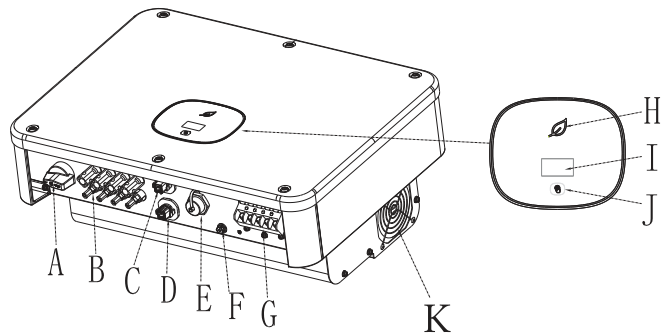

fig3.1 Appearance overview

The appearance instructions are as follows:

Numbering	name
A	DC switch
B	PV input terminal
C	COM port
D	COM port(optional)
E	USB port
F	Ground terminal
G	AC output terminal
H	LED indicator
I	OLED display
J	Touch button
K	External fan

Description of the identification on the inverter :

Identification	Description	Explanation
	Knock mark	Touch button: we can switch OLED display and set parameters by touch.
	Inverter status identification	Indicates the current operating state of the inverter. red: fault green: normal operation Flashing red light: warning Flashing green light: Update program

3.2 Dimensions

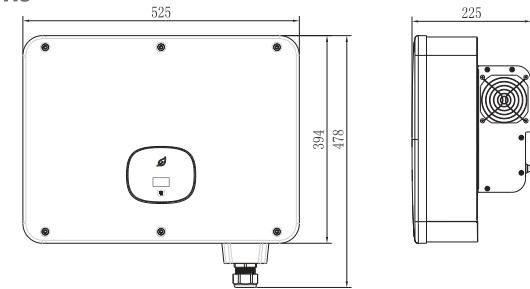

figure3.2 Dimensions

Size and weight:

Model	Height (H)	Width (W)	Depth (D)	Weight
MID 6-12KTL3-XL	525mm	394mm	221mm	23kg
MID 10-25KTL3-X	525mm	394mm	221mm	23kg

3.3 Storage Environment

If you want to store the inverter in the warehouse, you must choose a suitable location for the inverter.

- Equipment must be stored in its original packaging.
- Storage temperature should always be between -25 ° C and + 60 ° C, storage relative humidity is less than 90%.
- If you need to store a batch of inverters, the maximum number of layers in the original carton is 4.

4 Unpacking and Inspection

Before opening the inverter package, please check the outer packaging for damage. After unpacking, check the inverter for damage or missing accessories. In the event of damage or missing accessories, please contact your dealer.

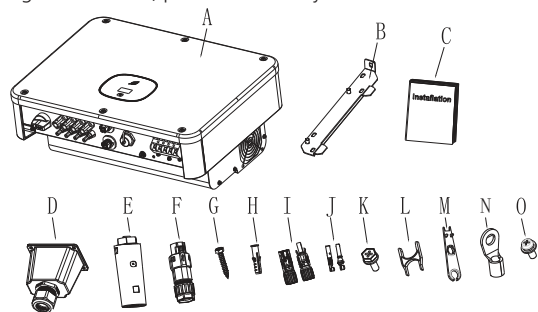

Numbering	Description	Quantity
A	Inverter	1
B	Wall bracket	1
C	quick guide	1
D	AC Waterproof cover	1
E	Collector (optional)	OPT
F	COM port signal connector	2
G	Self-tapping screw	4
H	Plastic expansion tube	4
I	PV+/PV- Terminal (25k model 5/5PCS)	4/4
J	PV+/PV- Metal terminal (25k model 5/5PCS)	4/4
K	Safety screw	1
L	Signal connector unloading tool	1
M	PV Terminal removal tool	1
N	14-6 O-type terminal	6
O	Fixed AC waterproof cover M4*10 screw	4
*	Warranty card	1
*	A copy of the business license	1
*	Certificate	1
*	Packing List	1
*	CQC report and certificate	1

Installation 5

5.1 Basic installation requirements

- The wall on which the inverter is mounted must be sturdy and can withstand the weight of the inverter for a long time (refer to the specifications in Chapter 12 for the weight of the inverter);
 - The installation location must match the size of the inverter;
 - Do not install the inverter on a building constructed of flammable or heat-resistant materials;
 - Install the inverter in an eye-view orientation to facilitate inspection of the OLED display and maintenance work;
 - The machine's degree of protection is IP65 and can be installed indoors and outdoors;
 - It is not recommended to expose the inverter directly to strong sunlight to prevent overheating and cause power derating;
 - The humidity of the installation environment should be between 0 and 90%;
 - The ambient temperature around the inverter should be between -25 °C ~ 60 °C;
 - The inverter can be mounted on a plane that is tilted vertically or backwards.
- Please refer to the following figure:

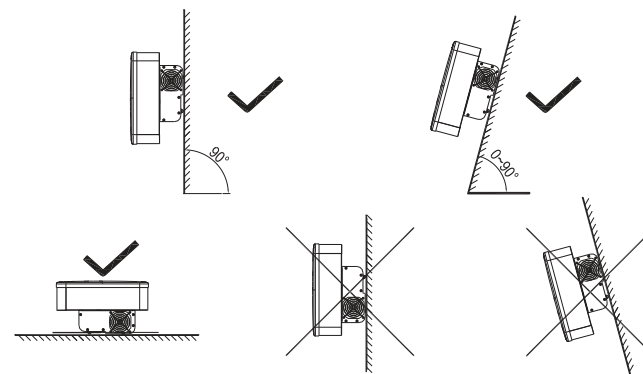

fig5.1 Installation diagram

- In order to ensure the normal operation of the machine and the convenience of personnel operation, please pay attention to provide sufficient clearance for the inverter. Please refer to the figure below:

Direction	Minimum clearance (mm)
Above	300
Under	500
Both sides	500
Forward	300

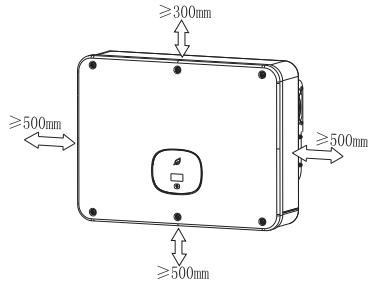

fig5.2 Mounting dimensions for an inverter

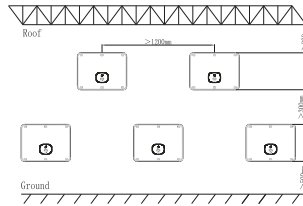

fig5.3 Mounting dimensions for multiple inverters

- Do not install the inverter on the TV antenna, other antennas or antenna cables;
- Do not install the inverter in the living area;
- Do not install the inverter where children can reach it;
- The inverter should be installed in a sheltered and protected location such as cool, rain-proof;



fig5.4 Installation Environment

- Make sure that the inverter is installed in a suitable place and is not allowed to be installed in a closed box;

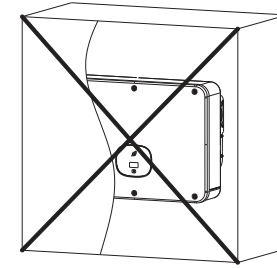

fig5.4 Closed box

- In order to reduce the inverter load and extend the life of the inverter due to direct sunlight, we recommend installing a awning. The distance between the awning and the inverter is as follows:

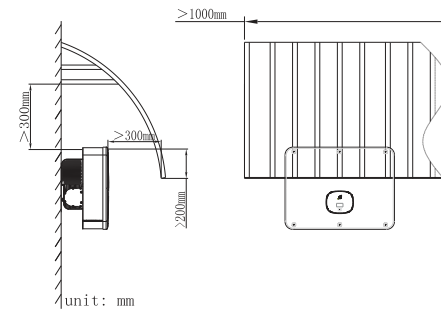

fig5.5 Awning

5.2 Mounting wall mount

5.2.1 Mounting wall mount



To prevent electric shock or other damage, be sure to check the wall for power or other piping before opening the hole in the wall.

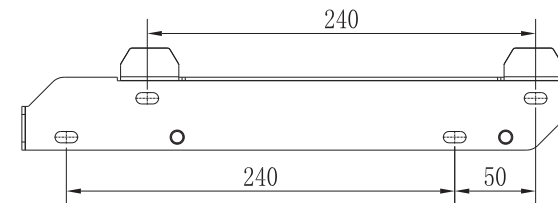

fig5.6 Wall mount specification

Inverter Wiring 6

Secure the wall mount as shown, do not let the screws flush with the wall, instead expose 2 to 4 mm.

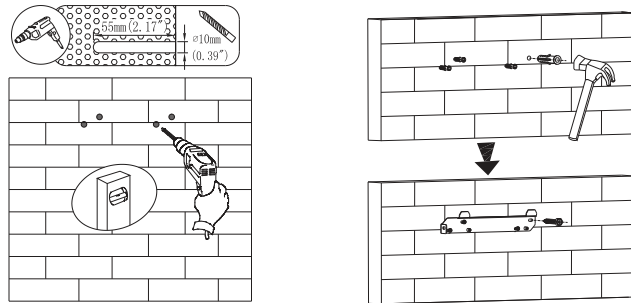

fig5.7 Wall mount installation diagram

5.3 Installing the inverter

Note: Before installing the inverter, you must first make sure that the wall mount is firmly fixed to the wall.

- steps:
1. Hang the inverter on the wall mount and keep the inverter balanced when hanging.
 2. To ensure that the inverter can be securely attached to the wall, secure the side of the inverter with the M5 safety screw on the left.

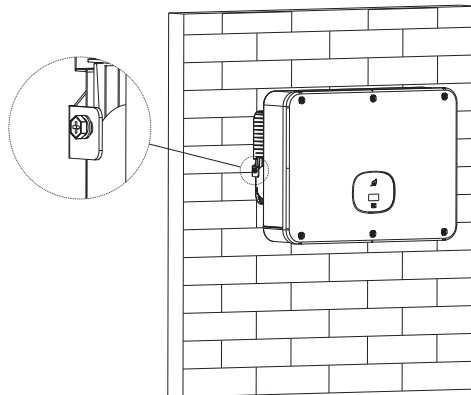







fig5.8 Inverter wall hanging diagram

6.1 Safety

 Danger	A high voltage in the conductive part of the inverter may cause an electric shock. Therefore, when performing any installation work on the inverter, make sure that the AC and DC sides of the inverter are powered off.
 Warning	Static electricity may cause damage to the electronic components of the inverter. Antistatic measures should be taken during the replacement or installation of the inverter.
 Note	Moisture and dust penetration can damage the inverter. <ul style="list-style-type: none"> ➤ Make sure the cable connector is securely tightened. ➤ If the cable connector is not installed correctly, the inverter may be damaged by moisture and dust. All warranty claims are invalid.

6.2 AC side wiring

 Danger	Before making electrical connections, make sure that the DC switch of the inverter is in the "OFF" state and that the AC side is open, otherwise the high voltage of the inverter may be life-threatening.
 Warning	<ul style="list-style-type: none"> ➤ Each inverter must be independently installed with an AC circuit breaker, and multiple inverters are prohibited from sharing. ➤ Do not use a single core wire at the inverter output. ➤ It is forbidden to use aluminum wire as the output cable. ➤ Please ensure that the output line is well connected before turning on the inverter. Ignoring the above warnings may damage the machine or cause other losses. In this case, the company has the right not to carry out the warranty, or bear any responsibility and related expenses.
 Note	Moisture and dust penetration can damage the inverter. <ul style="list-style-type: none"> ➤ Make sure the cable connector is securely tightened. ➤ If the cable connector is not installed correctly, the inverter may be damaged by moisture and dust. All warranty claims are invalid.

Residual current protection device:

Since the inverter itself has a high-precision residual current detecting device, it is not recommended to install a switch with leakage protection in the system. If for some special reason, it must be installed with leakage protection between the inverter output and the grid. For the switch, please install the B-type leakage protection switch of 300mA or more. When multiple leakage protection switches are installed in the system, the zero line sharing is prohibited. Otherwise, the leakage protection function may be triggered by mistake, causing the switch to trip.

Preparation before wiring :

Connect the protective ground wire (PE)

Connect the inverter to the grounding bar through the protective earth (PE) to achieve grounding protection.



- Good grounding is good for resisting surge voltage surges and improving EMI performance. Therefore, before connecting AC, DC, and communication cables, you need to ground the cable first.
- For a stand-alone system, simply ground the PE cable; for a multi-machine system, connect all the PE cables of the inverter to the same grounding copper bar to ensure equipotential bonding.

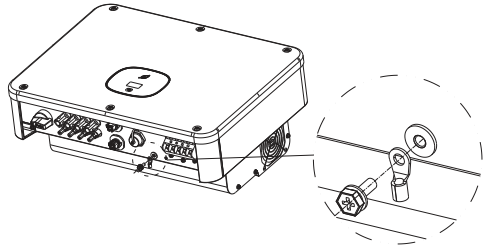

fig6.1 Grounding diagram

- Measuring the voltage and frequency of the public grid (voltage: AC 230V; frequency: 50Hz)

The recommended specifications for the AC output switch are as follows:

Inverter model	Switch specification	Inverter model	Switch specification
MID 6KTL3-XL	25A/127V	MID 8KTL3-XL	32A/127V
MID 10KTL3-XL	40A/127V	MID 11KTL3-XL	40A/127V
MID 12KTL3-XL	50A/127V	MID 10KTL3-X	32A/230V
MID 12KTL3-X	40A/230V	MID 15KTL3-X	40A/230V
MID 17KTL3-X	40A/230V	MID 20KTL3-X	40A/230V
MID 22KTL3-X	50A/230V	MID 25KTL3-X	50A/230V

AC connection steps:

1. The five wires (A, B, C, N, and PE wires) connected to the grid are passed through an AC shield and then coiled to the O / U terminal.

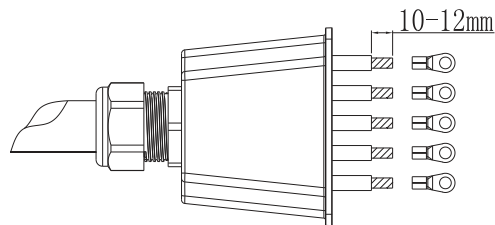

fig6.2 AC output line crimp terminal

1. Lock the AC cable to the corresponding AC terminal.

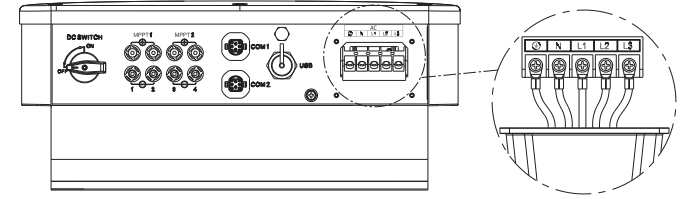

fig6.3 AC terminal wiring

2. Lock the shield on the inverter frame and finally tighten the shield hole.

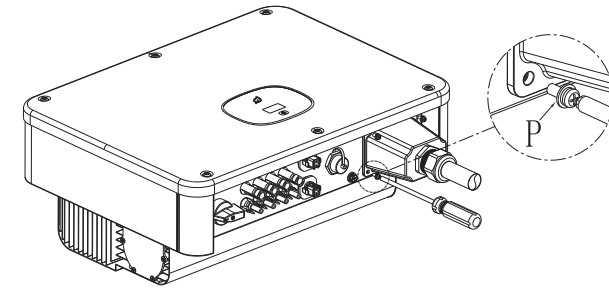





fig6.4 AC lock waterproof cover

Recommended line length:

Wire cross section	Maximum wire length					
	MID 6-8K TL3-XL	MID 10-11K TL3-XL	MID 12K TL3-XL	MID 10-15K TL3-X	MID 17-20K TL3-X	MID 22-25K TL3-X
10mm ²	50m	40m	30m	50m	40m	30m
16 mm ²	60m	50m	35m	60m	50m	35m

6.3 DC side wiring

 Danger	<ul style="list-style-type: none"> ➤ When the sun shines on the panel, voltage will be generated. The high voltage after the connection may cause life-threatening. Therefore, before connecting the DC input line, the panel should be shielded with opaque material before operation, and the inverter is ensured. The DC switch of the unit is in the "OFF" state, otherwise the high voltage of the inverter may be life-threatening. ➤ To avoid electric shock, do not touch the live parts and carefully connect the terminals. ➤ Make sure the AC switch is disconnected before wiring.
 Warning	<p>Please ensure that the following conditions are met, otherwise it may cause fire hazard or damage to the inverter. In this case, the company does not carry out warranty and assumes any responsibility.</p> <ul style="list-style-type: none"> ➤ The maximum open circuit voltage of each string of PV modules shall not exceed 1100Vdc under any conditions. ➤ The PV modules connected in series in the PV string are all of the same specification type. ➤ The maximum short-circuit current of each PV string shall not exceed 25A under any conditions. ➤ The total output power of all PV strings must not exceed the maximum input power of the inverter. ➤ In order to optimize the system configuration, it is recommended to connect the same number of PV modules with two inputs. ➤ If the inverter output is directly connected to the grid (ie the output side is not connected to the low frequency isolation transformer), make sure that the PV string is not grounded. ➤ If the inverter is for a specific model of the thin-film battery pack (PV-ground), please turn on the low-frequency isolation transformer after the output is connected, otherwise the inverter will be damaged. ➤ If it is measured that there is a stable non-zero DC voltage between the positive pole and the ground of the PV string, it indicates that an insulation fault has occurred at a certain position in the PV string, and it is necessary to ensure that the fault is repaired before continuing the wiring.
 Note	<p>Moisture and dust penetration can damage the inverter.</p> <ul style="list-style-type: none"> ➤ Make sure the cable connector is securely tightened. ➤ If the cable connector is not installed correctly, the inverter may be damaged by moisture and dust. All warranty claims are invalid.

The MID series inverter has two independent inputs, as shown below:

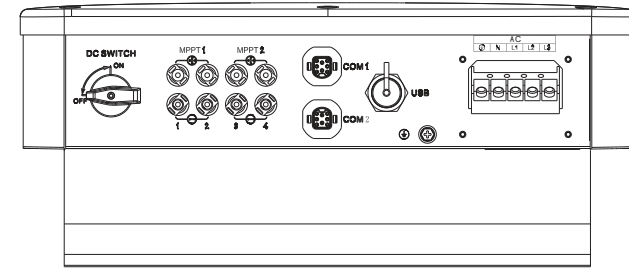



fig6.5 PV terminal

Note: MID 25KTL3-X model MPPT2 is 3 sets of PV input.

The selection of PV modules should pay attention to the following points:

- The PV modules of each PV string are of the same specification.
- The PV modules of each PV string are connected in series by the same number.

 Note	<ul style="list-style-type: none"> ➤ Before connecting the panel, please make sure that the DC input polarity is correct, that is, the positive pole of the PV module is connected to the DC input terminal of the inverter marked "+", and the negative pole is connected to the DC input terminal marked "-". ➤ The maximum DC input current and voltage of the inverter must not exceed the following limits: 		
	Model	Single maximum input current	Maximum input voltage
	MID 6-12KTL3-XL	25A	1100V
	MID 10-22KTL3-X	25A	1100V
	MID 25KTL3-X	25A/37.5A	1100V

Connecting DC terminal:

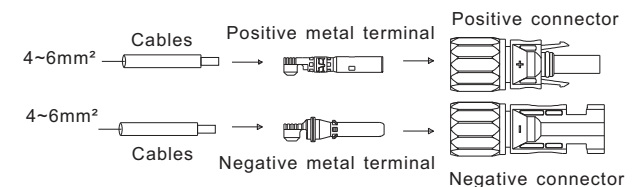

fig6.6 Quick installation instructions

6.4 Connecting signal line

The MID series inverter has an 8Pins signal connector, and the client signal line port is as follows:

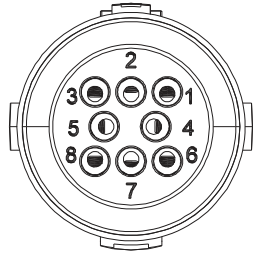

fig6.7 Quick installation instructions

1.Strip the cable 10mm through the waterproof gland, thread the sleeve, and tighten the screws. Make sure the cable is well connected.

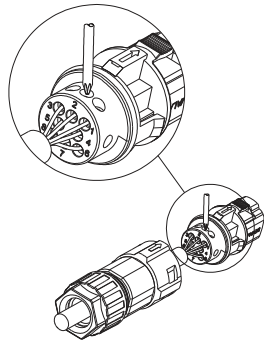

fig6.8 Quick installation instructions

2.Push the threaded sleeve into the socket and tighten the waterproof gland.

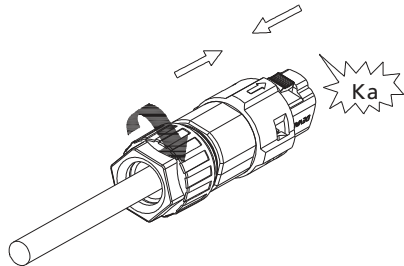

fig6.9 Quick installation instructions

3.Dock the client to the inverter plug until both are tightly locked to the inverter.

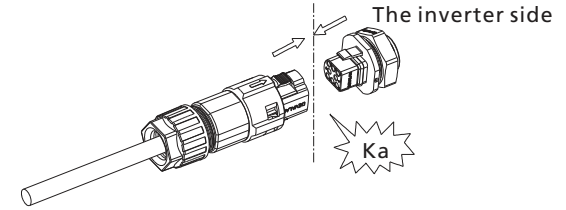

fig6.10 Quick installation instructions

Disassemble the signal connector

1.Press the fastener and pull it out of the inverter.

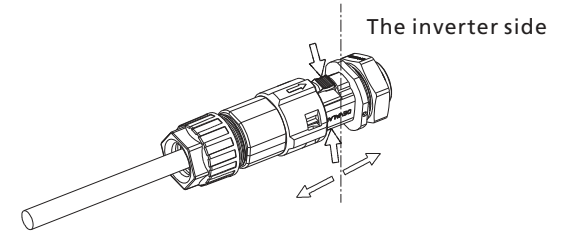

fig6.11 Quick installation instructions

2.Insert the H-tool and pull it out of the socket.

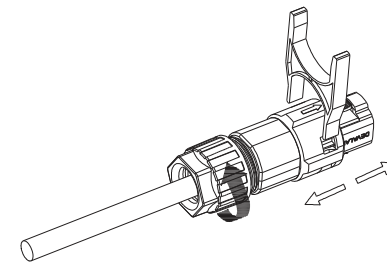

fig6.12 Quick installation instructions

7 Debugging

- 1) Close the DC switch on the inverter. As long as the input DC voltage is greater than 250V, the inverter display will display the following message: There is no AC connection error, the inverter LED will turn red.
If other information is displayed, please refer to Chapter 9. If you encounter problems during the debugging process, please contact customer service.
- 2) Close the circuit breaker or switch between the inverter and the grid. The inverter starts the self-test countdown. After the self-test is normal, it will be connected to the grid.
- 3) In normal operation, the leaves of the inverter indication window will turn green.
- 4) Complete debugging.

8 Operating Mode

8.1 Normal mode

In this mode, the inverter works normally.

- When the DC voltage is greater than 250V, the energy is sufficient and the grid voltage frequency meets the requirements of grid connection, the inverter converts the energy of the solar panel into an AC input grid, and the green LED lights up.
- When the DC voltage is lower than 180V, the inverter will automatically disconnect from the grid and exit the normal operation mode. When the input voltage reaches the requirement again and the grid voltage returns to normal, the inverter will automatically connect to the grid.

8.2 Failure mode

The inverter control chip monitors and adjusts the status of the system in real time. When the inverter monitors any unexpected conditions, such as system failure and inverter failure, the fault information will be displayed on the display. In the fault mode, the inverter indicates The leaves of the window turn red and the inverter output is disconnected from the grid.

8.3 Shutdown mode

When the light is weak or there is no sunlight, the inverter will automatically stop running. When in the shutdown mode, the inverter basically does not consume the energy of the grid or solar panels, and the inverter display and LED lights are turned off.

OLED Display and Touch Buttons 9

9.1 Boot display

The OLED display can display the operating status of the inverter and various parameter information. The touch panel can be used to switch the display interface of the inverter and set the inverter parameters.

9.1.1 The inverter information interface is as follows

(The dark blue arrow is click--the next page, the red arrow is the double-click--the sub-menu enters, the blue arrow is the triple-click--back)

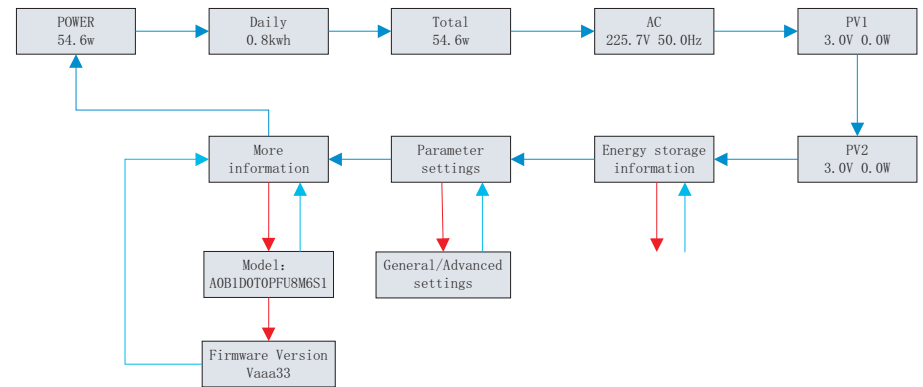

9.1.2 Parameter setting (general settings)

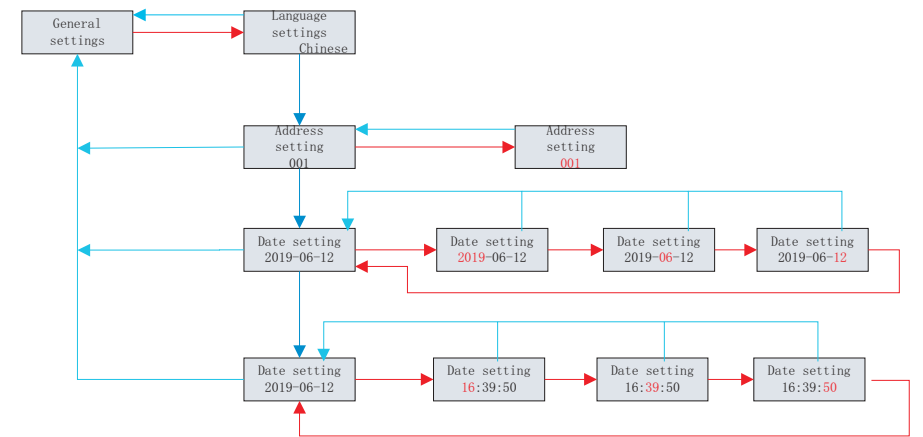

9.1.3 Parameter setting (advanced setting)

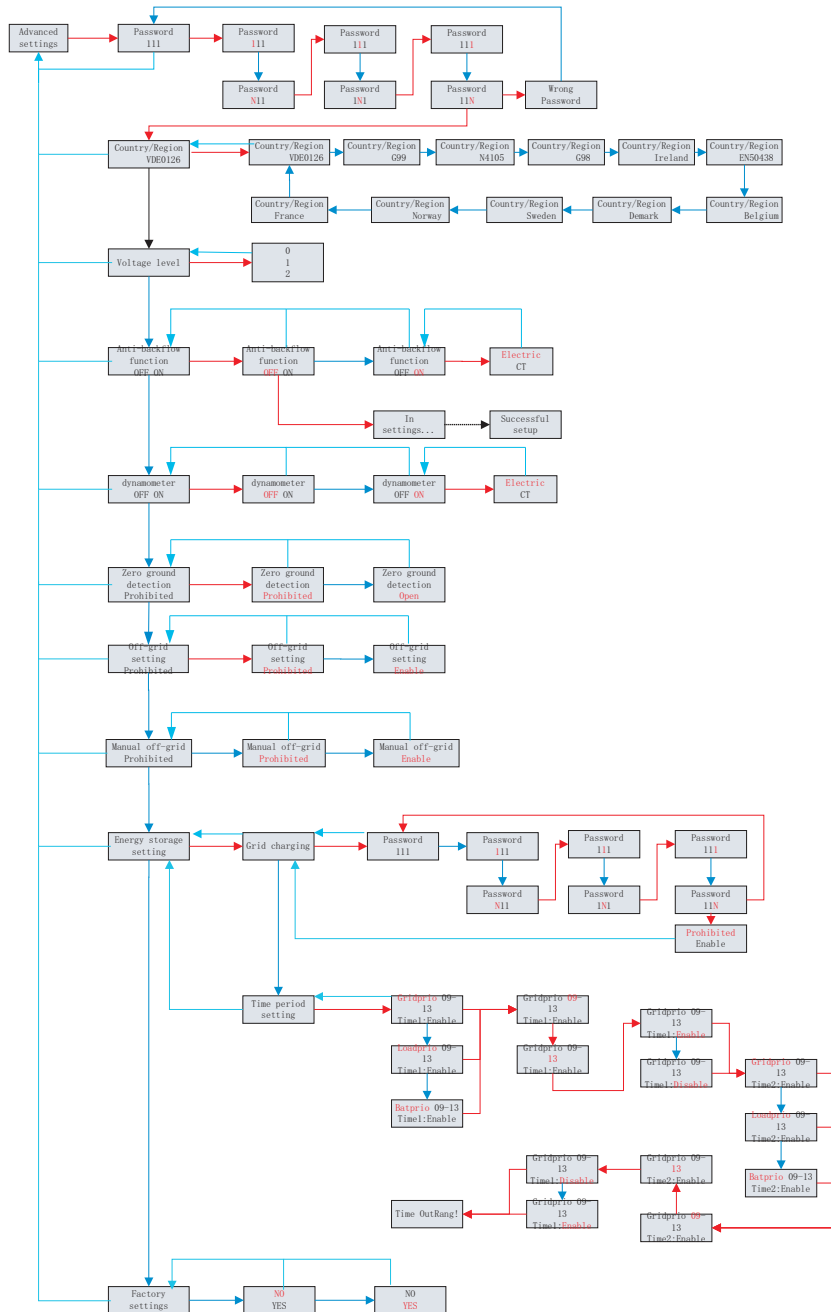

The main settings are as follows:

General settings				
Setting item	Language settings	Address setting	Date setting	Time setting
Advanced settings(requires password)				
Setting item	Country/Region	Voltage level	Anti-backflow function	Zero ground detection
	Off-grid setting	Manual off-grid	Energy storage setting	Other function settings
	Reset			

9.2 OLED display wake up

After the inverter works normally for 5 minutes, the OLED display will be automatically turned off. At this time, the OLED has no display, indicating that the leaf of the window is green, and it is necessary to view the display data or perform setting to enable the OLED to be redisplayed by touch operation.

9.3 Touch operation

The machine has a touch button and functions as follows:

- ① Touch once: switch function, turn to the next page or select the switch option in the setting item;
- ② Touch twice in succession: Confirm function, enter setting item or confirm setting;
- ③ Touch three times in succession: return/exit function, return to the previous menu or exit the current setting item;
- ④ Long press 5S: power-up country selection; data clear initial value;

10 Communication and Monitoring

10.1 RS485

This series of inverters provides two RS485 ports. You can monitor one or more inverters via RS485. Another RS485 port is used to connect to a smart meter (single machine anti-backflow function). The function of each pin is as follows:

Serial number	Function	Serial number	Function
1	DRY contact +	2	DRY contact -
3	RS485A1+ (Signal for monitor)	4	RS485B1- (Signal for monitor)
5	AntiReFlux-A (RS485A for meter)	6	AntiReFlux-B (RS485B for meter)

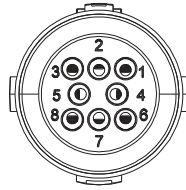

10.2 DRM

In addition to RS485 communication function, this series of inverters also have DRM communication function. The hardware interface is the same as 485. The functions of each pin are as follows:

Serial number	Function	Serial number	Function
1	DRM1/5 (Communication signal)	2	DRM2/6 (Communication signal)
3	DRM3/7 (Communication signal)	4	DRM4/8 (Communication signal)
5	REF	6	COM

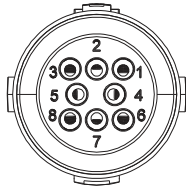

10.3 USB-A

USB-A port is mainly used to connect monitoring module or firmware update :

We can connect the external optional monitoring modules, such as Shine WIFI-X, Shine 4GX, Shine LAN-X, etc. to the USB interface for monitoring.

Steps for installing the monitoring module: Make sure ▲ is on the front side, then insert the collector and tighten the screws.

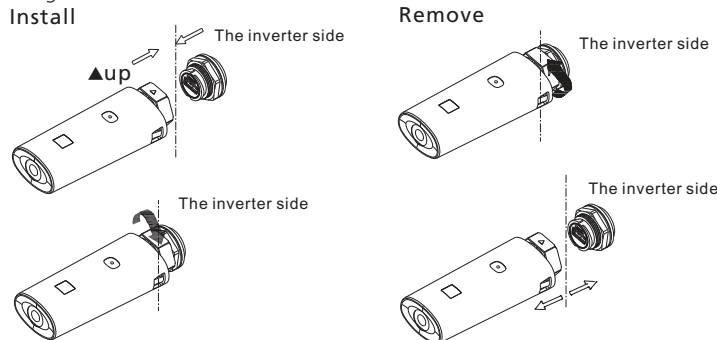

Start and Shut Down the Inverter 11

11.1 Start the inverter

1. Close the inverter AC circuit breaker.
2. Close the DC switch, when the input PV voltage is higher than 250Vdc, and the inverter will start automatically.

11.2 Shut down the inverter



Don't disconnect the DC connector while the inverter is connected to the grid.

Steps to turn off the inverter:

1. Disconnect the AC circuit breaker to prevent the inverter from starting again;
2. Turn off the DC switch;
3. Check the operating status of the inverter;
4. Wait until the LED and OLED display are off, indicating that the inverter is turned off.

Fan Maintenance 12



- Must be operated by the relevant electrical professional and follow the instructions.
- Be sure to disconnect the DC and AC switches for at least 10 minutes before operating to avoid danger.
- Please perform all operations after power off.



- Do not use a gas pump to clean the fan, as this may cause damage to the fan.

When the MID 6-12KL3-XL and MID 10-25KL3-X series inverters work in high temperature environment, good ventilation and heat dissipation can effectively reduce the probability of load reduction. The inverter is equipped with a cooling fan. When the external temperature is too high, the fan works to reduce the external temperature. If the inverter has low output due to excessive external temperature, the following are possible causes and countermeasures.

- The fan is clogged or there is too much dust on the heat sink. Under this circumstance, please clean the fan, fan cover or heat sink.
- The fan is damaged and the fan needs to be replaced.
- Poor ventilation of the inverter installation position, according to the basic installation requirements, choose the appropriate installation location.

Fan cleaning replacement steps

1. Before cleaning or replacing the fan, please make sure that the DC side and AC side of the inverter are disconnected.

1) Turn off the DC side switch.

2) Remove the DC side terminal (user needs to use the tool to disconnect the DC connection terminal).

3) Disconnect the AC side switch.

2. First remove the fan fixing plate screw with a screwdriver.

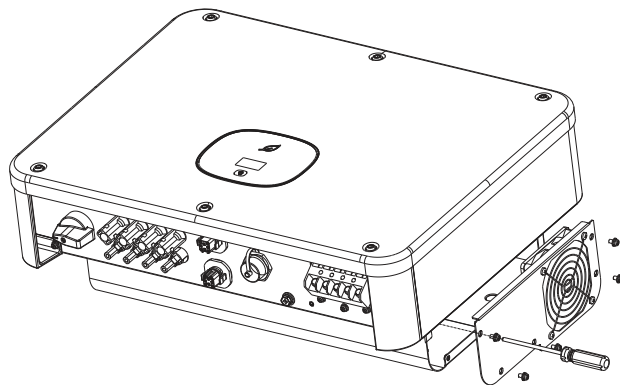

fig12.1 Remove the fan

3. Disconnect the fan connector, remove the fan fixing plate screw with a screwdriver, and finally remove the fan.

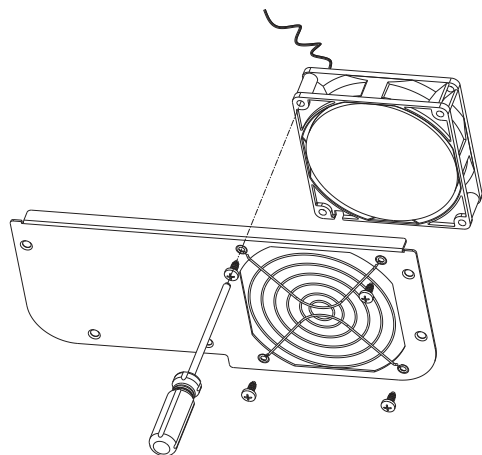

fig12.2 Remove the fan

4. Clean the fan, fan net and heat sink or replace the fan.

1) Clean the heat sink with a gas pump and clean the fan and fan net with a brush or a damp cloth.

2) Remove the fan and clean it separately if necessary.

3) Use a Phillips screwdriver to remove the fan that needs to be replaced.

4) Replace with a brand new fan.

5. Reinstall the fan mounting plate and inverter.

Troubleshooting 13

PV inverters sometimes do not work properly, we recommend the following solutions to eliminate common faults. The table below helps the technician understand the problem and take action.

13.1 Error message

When a failure occurs, an error message will be displayed on the OLED screen. Faults include system faults and inverter faults.

In some cases, you may be advised to contact Growatt, please provide the following information.

Information about the inverter:

- Serial number
- Model
- Error message on OLED
- a short description of the problem
- Grid voltage
- DC input voltage
- Have you ever had this problem in the past?
- What are the environmental conditions at the time of the problem?

Information about photovoltaic panels:

- The manufacturer name and model number of the PV panel
- Output power of the panel
- Open circuit voltage of the panel
- Vmp of the panel
- Maximum current per string
- Number of panels in each string

If you need to replace the device, please ship it to the original box.

13.2 System error

13.2.1 Warning code

Warning Code	Fault Discription	Suggestion
Warning 200	String fault	1. After shutdown,Check the panel is normal. 2. If error message still exists, contact manufacturer.
Warning 201	String PID quick connect terminal detection error	1. After shutdown,Check the string terminal wiring. 2. If the error message still exists, contact the manufacturer.
Warning 202	DC SPD function abnormal	1. After shutdown,Check the DC SPD. 2. If error message still exists,contact manufacturer.
Warning 203	PV Circuit short	1: Check the PV1 or PV2 wiring is short-circuited 2: If error message still exists,contact manufacturer.
Warning 204	Dryconnect function abnormal	1. After shutdown,Check the dry Dryconnect wiring. 2. If the error message still exists, contact manufacturer.
Warning 205	PV Boost driver broken	1. Restart inverter. 2. If error message still exists,contact manufacturer.
Warning 206	AC SPD function abnormal	1. After shutdown,Check the AC SPD. 2. If error message still exists,contact manufacturer.
Warning 207	U disk over-current protection	1: unplug the U disk 2: Re-access U disk after shutdown 3. If the error message still exists, contact manufacturer.
Warning 208	DC Fuse Open	1. After shutdown,Check fuse. 2. If error message still exists, contact manufacturer.
Warning 209	The DC input voltage is exceeding the maximum tolerable value.	1. Immediately disconnect the DC switch and check the voltage 2. If the fault code still exists after the normal voltage is restored, contact manufacturer
Warning 210	PV Reversed	1: Check PV input terminals 2: If error message still exists,contact manufacturer.

Warning Code	Fault Discription	Suggestion
Warning 300	No Utility	1. Please confirm grid is lost or not. 2. If error message still exists,contact manufacturer.
Warning 301	Grid voltage outrange	1. Check the AC voltage is in the range of standard voltage in specification. 2. If error message still exists,contact manufacturer.
Warning 302	Grid frequency outrange	1. Check the frequency is in the range of specification or not. 2. If error message still exists,contact manufacturer.
Warning 303	EPS mode, over load	1. Please reduce the load of EPS output. 2. If error message still exists,contact manufacturer.
Warning 304	CT Open	1: Check if AC current sensor is connected well. 2: If error message still exists,contact manufacturer.
Warning 305	SP-CT L N line reversed or Ground fail	1: Check the L line and N line of SP-CT is reversed or not. 2: If error message still exists,contact manufacturer.
Warning 306	Communication fault , M3 didn't receive SP-CT data	1: Check communication wire 2: If error message still exists,contact manufacturer.
Warning 307	Communication fault	1: Check communication wire 2: If error message still exists,contact manufacturer.
Warning 400	Fan function abnormal	1.After shutdown,Check the fan connection. 2. replace the fan. 3. If the error message still exists, contact manufacturer.
Warning 401	Meter abnormal	1: Check if the meter is on 2: Check the machine and the meter connection is normal .
Warning 402	Optimizer and inverter communication is abnormal	1. Check if the optimizer is on. 2. Check whether the connection between the optimizer and the inverter is normal.
Warning 403	String communication abnormal	1. After shutdown,Check the string panel wiring. 2. If the error message still exists, contact manufacturer .

Warning Code	Fault Discription	Suggestion
Warning 404	EEPROM abnormal.	1. Restart inverter. 2. If error message still exists,contact manufacturer.
Warning 405	DSP and COM firmware version unmatch	1. Check the firmware version. 2. If error message still exists,contact manufacturer.
Warning 406	Boost module error	1. Restart inverter 2. If error message still exists, contact manufacturer.
Warning 407	NTC Temperature too high or NTC is broken	1. Restart inverter 2. If error message still exists, contact manufacturer.
Warning 408	NTCBroken	1. Restart inverter 2. If error message still exists, contact manufacturer.
Warning 409	CT Connect abnormal	1. Check the CT connect Whether it is correct or not. 2. If error message still exists, contact manufacturer.

13.2.2 Error code

Error Code	Fault Discription	Suggestion
Error 200	AFCI Fault	1. After shutdown,Check the panel terminal. 2. Restart inverter. 3. If error message still exists,contact manufacturer.
Error 201	Leakage current too high	1. Restart inverter. 2. If error message still exists,contact manufacturer.
Error 202	The DC input voltage is exceeding the maximum tolerable value	1. Immediately disconnect the DC switch and check the voltage 2. If the fault code still exists after the normal voltage is restored, contact manufacturer
Error 204	PV Reversed	1. After shutdown,Check the inverter terminal. 2. Restart inverter. 3. If error message still exists,contact manufacturer.

Error Code	Fault Discription	Suggestion
Error 300	AC V Outrange	1. Check grid voltage. 2. If the error message still exists despite the grid voltage being within the tolerable range, contactmanufacturer.
Error301	AC terminals reversed	1: Check AC terminals 2: If error message still exists, contact manufacturer.
Error 302	No AC Connection	1. After shutdown,Check AC wiring. 2. If error message still exists,contact manufacturer.
Error 303	PE abnormal	1. Check PE,to ensure that the PE line contact good. 2. If error message still exists,contact Manufacturer
Error 304	AC F Outrange	1. Restart inverter. 2. If error message still exists,contact manufacturer.
Error 305	Over Load Fault	1. Check whether output load over range; If load too large, please reduce load. 2. If error message still exists, contact manufacturer.
Error 306	CT LN Reversed	1: After shutdown , Check the SP-CT connection. 2: If error message still exists,contact manufacturer.
Error 307	Communication fault,M3 didn't receive SP-CT data	1: Check communication wire 2: If error message still exists,contact manufacturer.
Error 308	Communication fault;Pairing time too long	1: Restart pairing 2: If error message still exists,contact manufacturer.
Error 400	DCI bias abnormal	1. Restart inverter 2. If error message still exists, contact manufacturer.
Error 401	DC Voltage High Fault	1. Restart inverter. 2. If error message still exists,contact manufacturer.
Error 402	Output DC current too high	1. Restart inverter. 2. If error message still exists,contact manufacturer.

Error Code	Fault Discription	Suggestion
Error 403	Output current unbalance	1: After shutdown,Check the output current is not balanced. 2: If the error message still exists, contact manufacturer.
Error404	bus sample fault	1. Restart inverter. 2. If error message still exists,contact manufacturer.
Error 405	Relay fault	1. Restart inverter. 2. If error message still exists,contact manufacturer.
Error 406	Init model fault	1. Reset mode. 2. If error message still exists,contact manufacturer.
Error 407	AutoTest failure	1. Restart inverter. 2. If error message still exists,contact manufacturer.
Error 408	NTC Temperature too high	1. After shutdown,Check the temperature, normal restart the inverter. 2. If the error message still exists, contact manufacturer.
Error 409	Bus voltage abnormal	1. Restart inverter. 2. If error message still exists,contact manufacturer.
Error 410	Redundant sample circuit of Insulation values are different	1. Restart inverter. 2. If error message still exists,contact manufacturer.
Error 411	Communication fault	1. After shutdown,Check communication board wiring 2. If the error message still exists, contact manufacturer
Error 412	Temperature sensor connection is abnormal	1. After shutdown,Check the temperature sampling module is connected properly. 2. If the error message still exists, contact manufacturer.
Error 413	IGBT drive fault	1. Restart inverter. 2. If error message still exists,contact manufacturer.
Error 414	EEPROM fault	1. Restart inverter. 2. If error message still exists, contact manufacturer.
Error 415	Internal power test fail (PV Power low)	1. Restart inverter. 2. If error message still exists,contact manufacturer.

Error Code	Fault Discription	Suggestion
Error 416	Over current protected by software	1. Restart inverter. 2. If error message still exists,contact manufacturer.
Error417	Grid voltage sampling is inconsistent	1. Restart inverter. 2. If error message still exists,contact manufacturer.
Error 418	DSP and COM firmware version unmatch	1. Check the firmware version. 2. If error message still exists,contact manufacturer.
Error 419	Redundant sample circuit of GFCI values are different	1. Restart inverter. 2. If error message still exists,contact manufacturer.
Error 420	GFCI Module damage	1: After shutdown,Check the leakage current module. 2: If the error message still exists, contact manufacturer.
Error 421	CPLD is abnormal	1. Restart inverter. 2. If error message still exists,contact manufacturer.
Error 422	sampling is inconsistent	1. Restart inverter. 2. If error message still exists,contact manufacturer.
Error 423	Battery Reverse Protect Fault	1. Restart inverter. 2. If error message still exists, contact manufacturer.
Error 424	Communication board and control panel sampling battery voltage is inconsistent	1. Restart inverter. 2. If error message still exists, contact manufacturer.
Error 425	AFCI self-test fault	1. Restart inverter. 2. If error message still exists, contact manufacturer.

14 Specification

14.1 Parameter

Model	MID 6KTL3-XL	MID 8KTL3-XL	MID 10KTL3-XL	MID 11KTL3-XL	MID 12KTL3-XL
Input data(DC)					
Max. recommended PV power(for module STC)	7800W	10400W	13000W	13000W	15600W
Max. DC voltage	800V				
Start voltage	250V				
Nominal voltage	360V				
MPP voltage range	160-800V				
Full-load voltage range	280-640V				
No. of MPP trackers	2				
No. of PV strings per MPP trackers	2				
Max. input current per MPP trackers	25				
Max. short-circuit current per MPP trackers	32				
Output data(AC)					
AC nominal power	6000W	8000W	10000W	11000W	12000W
Max. AC apparent	6600VA	8800VA	11100VA	12100VA	13300VA
Nominal AC voltage/range	133V/230V				
AC grid frequency/range	50/60 Hz 45~55Hz/55-65 Hz				
Max. output current	16.5A	22.1A	27.8A	30.3A	33.3A
Power factor(@nominal power)	>0.99				
Adjustable power factor	0.8Leading ...0.8Lagging				
THDi	<3%				
AC grid connection type	3W+PE /3W+N+PE				
Efficiency					
Max. efficiency	98.65%				
Euro-eta	98.3%				

Model	MID 6KTL3-XL	MID 8KTL3-XL	MID 10KTL3-XL	MID 11KTL3-XL	MID 12KTL3-XL
Protection devices					
DC reverse-polarity protection	YES				
DC switch	YES				
DC Surge protection	typell				
Insulation resistance monitoring	YES				
AC surge protection	typell				
AC short-circuit protection	YES				
Grid monitoring	YES				
Anti-islanding protection	YES				
Residual-current monitoring unit	YES				
String Fuse protection	YES				
String monitoring	OPT				
AFCI protection	OPT				
General data					
Dimensions (W / H / D) in mm	525*395*222mm				
Weight	23kg				
Operating temperature range	-25°C ... +60°C (>45°C Derating)				
Noise emission (typical)	≤40dB(A)				
Altitude	4000m				
Internal consumption at night	1W				
Topology	Transformerless				
Cooling	Fan cooling				
Electronics protection degree	IP65				
Relative humidity	0~100%				
DC connection	H4/MC4(OPT)				
AC connection	Cable gland+OT terminal				
Interfaces					
Display	OLED+LED/WIFI+APP				
USB/RS485	YES				
WIFI/GPRS/4G	OPT				

Model Specifications	MID 10KTL3-X	MID 12KTL3-X	MID 15KTL3-X	MID 17KTL3-X
Input data(DC)				
Max. recommended PV power(for module STC)	13000W	15600W	19500W	22100W
Max. DC voltage	1100V			
Start voltage	250V			
Nominal voltage	580V			
MPP voltage range	160-1000V			
Full-load voltage range	280-850V	280-850V	420-850V	480-850V
No. of MPP trackers	2			
No. of PV strings per MPP trackers	2			
Max. input current per MPP trackers	25			
Max. short-circuit current per MPP trackers	32			
Output data(AC)				
AC nominal power	10000W	12000W	15000W	17000W
Max. AC apparent	11100VA	13300VA	16600VA	18800VA
Nominal AC voltage/range	230V/400V 340-440V			
AC grid frequency/range	50/60 Hz 45~55Hz/55-65 Hz			
Max. output current	16.0A	19.3A	24.2A	27.4A
Power factor(@nominal power)	>0.99			
Adjustable power factor	0.8Leading ...0.8Lagging			
THDi	<3%			
AC grid connection type	3W+N+PE			
Efficiency				
Max. efficiency	98.65%			
Euro-eta	98.3%			

Model Specifications	MID 10KTL3-X	MID 12KTL3-X	MID 15KTL3-X	MID 17KTL3-X
Protection devices				
DC reverse-polarity protection	YES			
DC switch	YES			
DC Surge protection	typell			
Insulation resistance monitoring	YES			
AC surge protection	typell			
AC short-circuit protection	YES			
Grid monitoring	YES			
Anti-islanding protection	YES			
Residual-current monitoring unit	YES			
String Fuse protection	YES			
String monitoring	OPT			
AFCI protection	OPT			
General data				
Dimensions (W / H / D) in mm	525*395*222mm			
Weight	23kg			
Operating temperature range	-25°C ... +60°C (>45°C Derating)			
Noise emission (typical)	≤40dB(A)			
Altitude	4000m			
Internal consumption at night	1W			
Topology	Transformerless			
Cooling	Fan cooling			
Electronics protection degree	IP65			
Relative humidity	0~100%			
DC connection	H4/MC4(OPT)			
AC connection	Cable gland+OT terminal			
Interfaces				
Display	OLED+LED/WIFI+APP			
USB/RS485	YES			
WIFI/GPRS/4G	OPT			

Specifications \ Model	MID 20KTL3-X	MID 22KTL3-X	MID 25KTL3-X
Input data(DC)			
Max. recommended PV power(for module STC)	26000W	28600W	325000W
Max. DC voltage	1100V		
Start voltage	250V		
Nominal voltage	580V		
MPP voltage range	160-1000V		
Full-load voltage range	480-850V	520-850V	520-850V
No. of MPP trackers	2		
No. of PV strings per MPP trackers	2	2	2/3
Max. input current per MPP trackers	25	25	25/37.5
Max. short-circuit current per MPP trackers	32	32	32/48
Output data(AC)			
AC nominal power	20000W	22000W	25000W
Max. AC apparent	22000VA	24400VA	27700VA
Nominal AC voltage/range	230V/400V 340-440V		
AC grid frequency/range	50/60 Hz 45~55Hz/55-65 Hz		
Max. output current	31.9A	35.5A	40.2A
Power factor(@nominal power)	>0.99		
Adjustable power factor	0.8Leading ...0.8Lagging		
THDi	<3%		
AC grid connection type	3W+N+PE		
Efficiency			
Max. efficiency	98.65%		
Euro-eta	98.3%		

Specifications \ Model	MID 20KTL3-X	MID 22KTL3-X	MID 25KTL3-X
Protection devices			
DC reverse-polarity protection	YES		
DC switch	YES		
DC Surge protection	typell		
Insulation resistance monitoring	YES		
AC surge protection	typell		
AC short-circuit protection	YES		
Grid monitoring	YES		
Anti-islanding protection	YES		
Residual-current monitoring unit	YES		
String Fuse protection	YES		
String monitoring	OPT		
AFCI protection	OPT		
General data			
Dimensions (W / H / D) in mm	525*395*222mm		
Weight	23kg		
Operating temperature range	-25°C ... +60°C (>45°C Derating)		
Noise emission (typical)	≤40dB(A)		
Altitude	4000m		
Internal consumption at night	1W		
Topology	Transformerless		
Cooling	Fan cooling		
Electronics protection degree	IP65		
Relative humidity	0~100%		
DC connection	H4/MC4(OPT)		
AC connection	Cable gland+OT terminal		
Interfaces			
Display	OLED+LED/WIFI+APP		
USB/RS485	YES		
WIFI/GPRS/4G	OPT		

14.2 Torque

Housing end cap screw	12kgf.cm
AC terminal block	14kgf.cm
Signal connector screw	4kgf.cm
Safety screw on the wall mount	20kgf.cm
Ground screw	20kgf.cm

14.3 Annex

Product attachments can be selected from the table below:

Name	Brief
Shine GPRS-X	USB interface GPRS monitoring module
Shine WIFI-X	USB interface WIFI monitoring module
Shine 4G-X	USB interface 4G monitoring module
Shine RF-X	USB interface RF monitoring module
Shine LAN-X	USB interface LAN monitoring module

Repair of the inverter can be on-site repair or transport the inverter to the Growatt Service Center for repair, or replace the new machine with the equivalent of the machine model and age.

The warranty does not cover the cost of recycling the defective equipment. The cost of installing or reinstalling a faulty device should also be explicitly excluded from other related logistics and processing costs associated with warranty claims associated with various aspects.

If you have technical questions about our products, please contact the Growatt New Energy Service Hotline. We need the following information to provide you with the necessary help:

- Inverter type
- Inverter serial number
- Inverter error message code
- Inverter OLED display content
- Type and number of PV modules connected to the inverter
- Inverter communication method

Shenzhen Growatt New Energy Technology CO.,LTD

No.28 Guangming Road, Shiyan Street, Bao'an District, Shenzhen, P.R.China

T +86 755 2747 1942

E service@ginverter.com

W www.ginverter.com